



19011101A01

1. Overview

Thank you for purchasing the GL10-0016ETP digital output expansion module developed by Inovance.

This product is a 16-channel digital transistor (SOURCE) output module used together with the AM600 series medium-sized PLC and the H3U series PLC main modules.

This guide describes the specifications, characteristics and using methods of the product. Read this guide carefully before using to ensure more safety usage. You can find more information on our website (www.inovance.com).

Approvals

Certification marks on the product nameplate indicate compliance with the corresponding certificates and standards.

Certification	Mark	Directives		Standard
CE		EMC directives	2014/30/EU	EN61131-2
		LVD directives	2014/35/EU	EN 61010-1 EN61010-2-201
		RoHS directives	2011/65/EU	EN 50581

Note:

- For more information on certification, consult our distributor or sales representative

2. Safety Information and Precautions

Safety information and precautions are identified into two grades: Warning and Caution. Please make sure to operate properly with adequate safety assurance.

- WARNING** Indicates the improper operation which, if not avoided, may cause death or serious injury.
- CAUTION** Indicates the improper operation which, if not avoided, may cause moderate or minor injury, as well as equipment damage.

In some cases, even failure to follow "Cautions" may also lead to serious consequences. Please make sure to follow both warnings and cautions, otherwise, it may cause death or serious injury, as well as product and relevant equipment and system damage.

Please keep this guide well so that it can be read when necessary and forward this guide to the end user.

During control system design

- WARNING** Provide a safety circuit outside the PLC so that the control system can still work safely once external power failure or PLC fault occurs.
- Add a fuse or circuit breaker because the module may smoke or catch fire due to long-time overcurrent caused by operation above rated current or load short-circuit.

- CAUTION**
- An emergency stop circuit, a protection circuit, a forward/reverse operation interlocked circuit, and a upper position limit and lower position limit interlocked circuit must be set in the external circuits of PLC to prevent damage to the machine.
 - To ensure safe operation, for the output signals that may cause critical accidents, please design external protection circuit and safety mechanism;
 - Once PLC CPU detects abnormality in the system, all outputs may be closed; however, when a fault occurs in the controller circuit, the output may not be under control. Therefore, it is necessary to design an appropriate external control circuit to ensure normal operation;
 - If the PLC's output units such as relays or transistors are damaged, the output may fail to switch between ON and OFF states according to the commands;
 - The PLC is designed to be used in indoor electrical environment (overvoltage category II). The power supply must have a system-level lightning protection device, assuring that overvoltage due to lightning shock can't be applied to the PLC's power supply input terminals, signal input terminals and output terminals and so forth, so as to avoid damage to the equipment.

During installation & wiring

- WARNING**
- Installation and wiring must be carried out by the specialists who have received the necessary electrical training and understood enough electrical knowledge.
 - Disconnect all external power supplies of the system before module assemble/disassemble and wiring. Failure to do so may result in electric shock, module fault or malfunction.
 - Do not use the PLC where there are dust, oil smoke, conductive dust, corrosive or combustible gases, or exposed to high temperature, condensation, wind & rain, or subject to vibration and impact. Electric shock, fire and malfunction may also result in damage or deterioration to the product.
 - The PLC is an open-type that must be installed in a control cabinet with lock (cabinet housing must satisfy protection of over IP20). Only the personnel who have the necessary electrical training and experience can open the cabinet.
 - Install the terminal cover attached to the product before power-on or operation after wiring is completed. Failure to comply may result in electric shock.
 - Perform good insulation on terminals so that insulation distance between cables will not reduce after cables are connected to terminals. Failure to comply may result in electric shock or damage to the equipment.

- CAUTION**
- Prevent metal filings and wire ends from dropping into ventilation holes of the PLC during installation and wiring. Failure to comply may result in fire, fault and malfunction.
 - Ensure there are no foreign matters on ventilation surface. Failure to comply may result in poor ventilation, which may cause fire, fault and malfunction.
 - Ensure the module is connected to the respective connector securely and hook the module firmly. Improper installation may result in malfunction, fault or fall-off.
 - The external wiring specification and installation method must comply with local regulations. For details, see the wiring section in this guide.
 - To ensure safety of equipment and operator, use cables with sufficient diameter and connect the cables to ground reliably.
 - Wire the module correctly after making clear of the connector type. Failure to comply may result in module and external equipment fault.
 - Tighten bolts on the terminal block in the specified torque range. If the terminal is not tight, short-circuit, fire or malfunction may be caused. If the terminal is too tight, fall-off, short-circuit, fire or malfunction may be caused.
 - If the connector is used to connect with external equipment, perform correct crimping or welding with the tool specified by manufacturer. If connection is in poor contact, short-circuit, fire or malfunction may be caused.
 - A label on the top of the module is to prevent foreign matters entering the module. Do not remove the label during wiring. Remember to remove it before system operation, facilitating ventilation.
 - Do not bundle control wires, communication wires and power cables together. They must be run with distance of more than 100 mm. Otherwise, noise may result in malfunction.
 - Select shielded cable for high-frequency signal input/output in applications with serious interference so as to enhance system anti-interference ability.

During maintenance & inspection

- WARNING**
- Maintenance & inspection must be carried out by personnel who have the necessary electrical training and experience.
 - Do not touch the terminals while the power is on. Failure to comply may result in electric shock or malfunction.
 - Disconnect all external power supplies of the system before cleaning the module or re-tightening screws on the terminal block or screws of the connector. Failure to comply may result in electric shock.
 - Disconnect all external power supplies of the system before removing the module or connecting/removing the communication wirings. Failure to comply may result in electric shock or malfunction.

During maintenance & inspection

- CAUTION**
- Get acquainted with the guide and ensure safety before online modification, forcible output, and RUN/STOP operation.
 - Disconnect the power supply before installing/removing the extension card.

At disposal

- CAUTION**
- Treat scrapped module as industrial waste. Dispose the battery according to local laws and regulations..

3. Product Information

Model and Nameplate

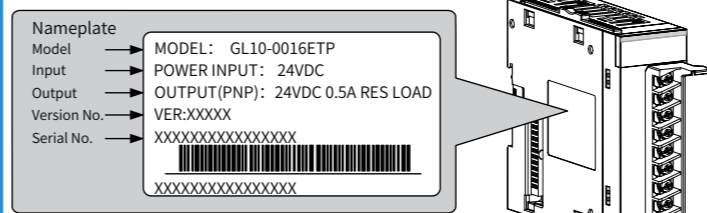
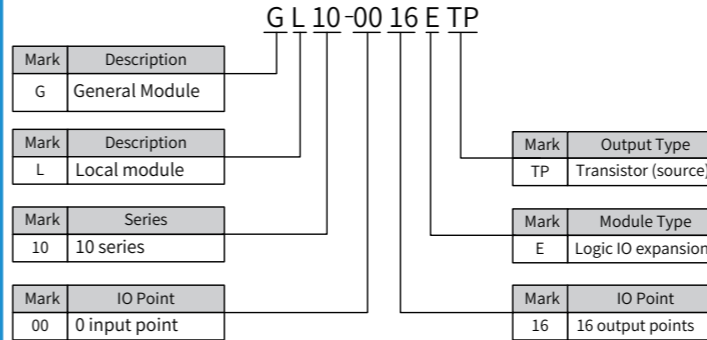

Figure 1 Description of model and nameplate

Model	Classification	Description	Applicable to
GL10-0016ETP	Digital transistor output (Source)	16-point DO module; transistor output (Source)	AM600 series, H3U

External Interface

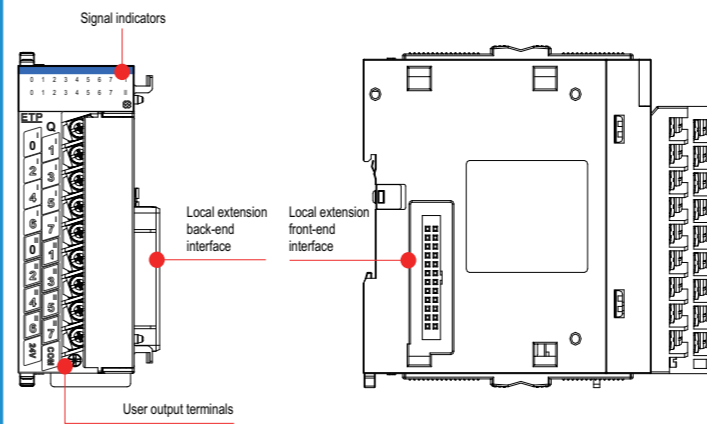

Figure 2 Diagram of digital output module interface

Interface Name	Function
User output terminals	2groups output with 8 channels in each group
Signal indicators	Corresponding to various output signal ON: output active OFF: output inactive
Local expansion module back-end interface	Connect back-end module, not supporting hot plugging
Local expansion module front-end interface	Connect front-end module, not supporting hot plugging

General Specifications

Item	GL10-0016ETP	
Output channel	16	
Output connecting mode	18-point wiring terminal	
Output type	Transistor, high-side output	
Output mode	SOURCE	
Supply voltage	24 Vdc (-15% to +20%)	
Internal 5 V power consumption	65 mA (typical value)	
Output voltage class	12 V to 24 V (-5% to 20%)	
Maximum leakage current when the module is turned OFF	Less than 0.5 mA	
Response time when the module is turned ON	Less than 0.5 ms (for hardware)	
Response time when the module is turned OFF	Less than 0.5 ms (for hardware)	
Maximum load	Resistive load	0.5 A/point; 2 A/common
	Inductive load	12 W/24 Vdc (total)
	Lamp load	2 W/24 Vdc (total)
Isolation method	Opto-couplers isolation	
Output action display	Output indicator is ON when optocoupler driving is applied	
Short circuit-proof output	Yes, the current is limited to 1 A ~ 1.7 A when short protection is applied	

4. Mechanical Design Reference

Mounting Dimensions

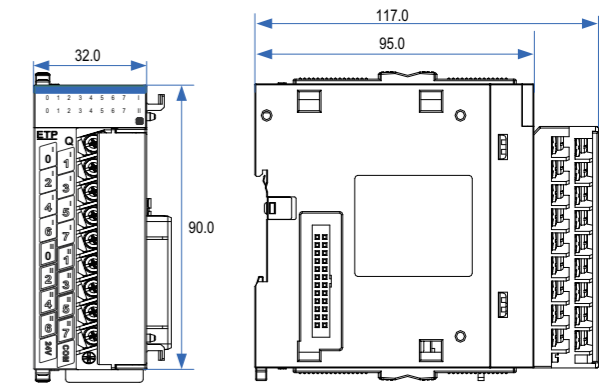

Figure 3 Mounting dimensions (in mm)

5. Electrical Design Reference

Cable Selection

Cable Name	Model	Applicable Cable Diameter		Manufacturer	Crimping Tool
		MM ²	AWG		
Y-type cable lug	TNS1.25-3	0.5-0.75	22-18	Suzhou Yuanli	RYO-8 YYT-8

Those cable lugs are applicable to digital/analog modules, and the cable rated temperature is required to be above 75 °C.

Cable Preparing Procedures

- Strip back the wire outer coating by 6 mm.
- Pass the cable through the tube of proper wire size.
- Insert the exposed end into the hole of the cable lug, and then crimp it with recommended crimping tool.
- Use heat-shrink tube (Φ3) of 20 mm long to wrap the copper tube of the cable lug and then perform thermal shrinkage.

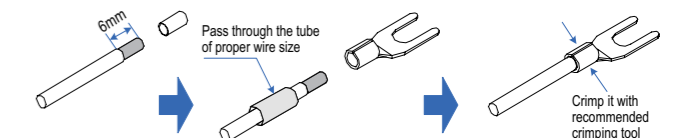

Figure 4 Diagram of cable preparing

- Put the cable lug onto the terminal and tighten the screw with a screwdriver. The maximum tightening torque is 0.8 N.m.

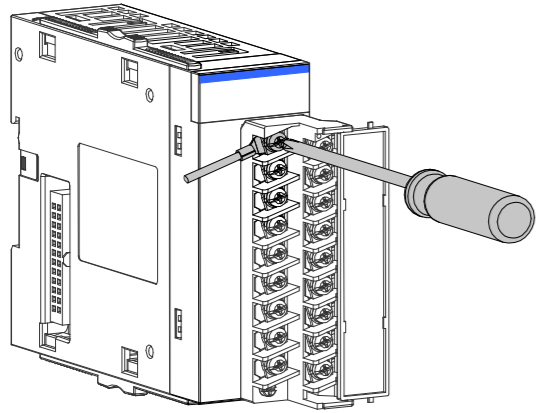

Figure 5 Connecting cable to terminal block

Terminal Arrangement

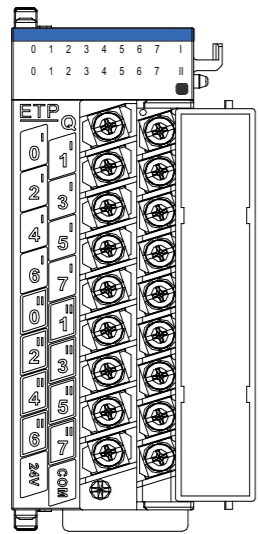

Figure 6 Terminal definition of analog input module

Terminal Definition

SN	Network Name	Type	Function	Remark
Interface for the 1st group of outputs				
1	Q0	Output	User output 0 in the 1st group	SOURCE output, active high
2	Q1	Output	User output 1 in the 1st group	SOURCE output, active high
3	Q2	Output	User output 2 in the 1st group	SOURCE output, active high
4	Q3	Output	User output 3 in the 1st group	SOURCE output, active high
5	Q4	Output	User output 4 in the 1st group	SOURCE output, active high
6	Q5	Output	User output 5 in the 1st group	SOURCE output, active high
7	Q6	Output	User output 6 in the 1st group	SOURCE output, active high
8	Q7	Output	User output 7 in the 1st group	SOURCE output, active high
Interface for the 2nd group of outputs				
9	Q0	Output	User output 0 in the 2nd group	SOURCE output, active high
10	Q1	Output	User output 1 in the 2nd group	SOURCE output, active high
11	Q2	Output	User output 2 in the 2nd group	SOURCE output, active high
12	Q3	Output	User output 3 in the 2nd group	SOURCE output, active high
13	Q4	Output	User output 4 in the 2nd group	SOURCE output, active high
14	Q5	Output	User output 5 in the 2nd group	SOURCE output, active high
15	Q6	Output	User output 6 in the 2nd group	SOURCE output, active high
16	Q7	Output	User output 7 in the 2nd group	SOURCE output, active high
Power connector				
17	24 V	Power supply	24 V power supply	-
18	COM	Power supply	Power ground	-

External Wiring

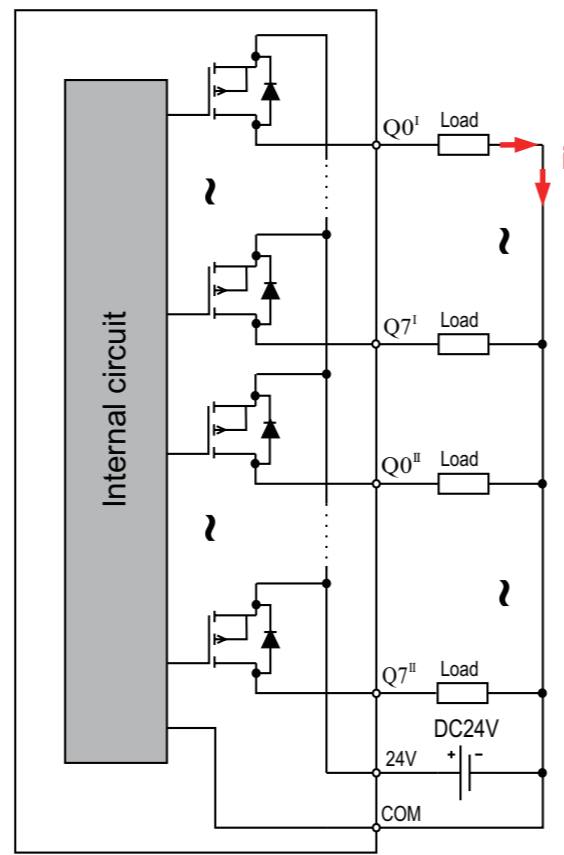

Figure 7 GL10-1600ETP module wiring

Wiring Precautions

- Do not bundle the extension cable together with power cables (high voltage, large current) which produce strong interference signals. Separate it from other cables and avoid cabling in parallel.
- Select recommended cables and pinboards for connection. It is recommended that shielded cables be used as extension cables to enhance capacity of resisting interference.

6. Programming Examples

Programming Example for AM600+GL10-0016ETP Module

Use AM600CPU as the main control module and set the first channel of two groups of outputs of the GL10-0016ETP to active; the usage of GL10-0016ETP is described as follows:

- Create a project and perform hardware configuration as follows:

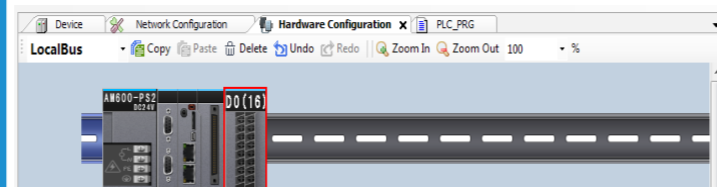

- Use ST programming language to program the ETP module, define the mapping variables Q1_0 and Q2_0, and set corresponding channels of mapping variables to active.

```

PROGRAM PLC_PRG
VAR
  Q1_0: BOOL;
  Q2_0: BOOL;
END_VAR

Q1_0:=TRUE;
Q2_0:=TRUE;
    
```

- Map the mapping variables Q1_0 and Q2_0 defined in the program to the first channel of two groups of the GL10-0016ETP module respectively, shown in the following figure.

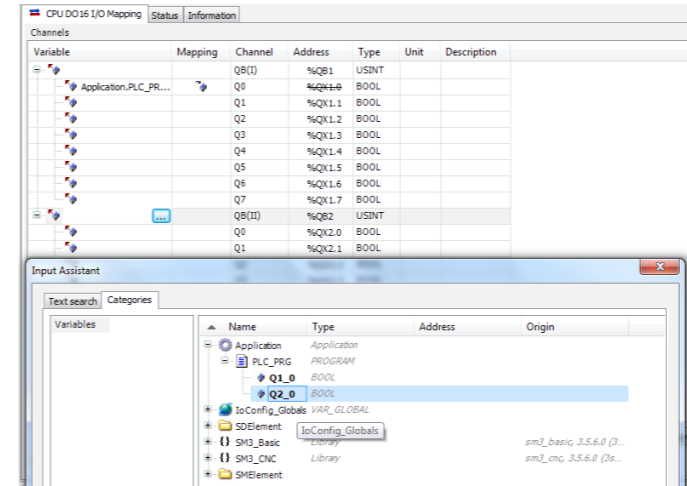

- After successful compiling, download the project and run it.

Programming Example for H3U + GL10-0016ETP Module

Use H3U as the main control module and set the first channel of the GL10-0016ETP module to active; the usage of GL10-0016ETP is described as follows:

- Create a project, select "H3U". Then the system enters the main page. Click "Configuration"; Right-click "Network Configuration", and then click "Create a New Module Configuration"; The simulation graphics of the rack to be configured appears:

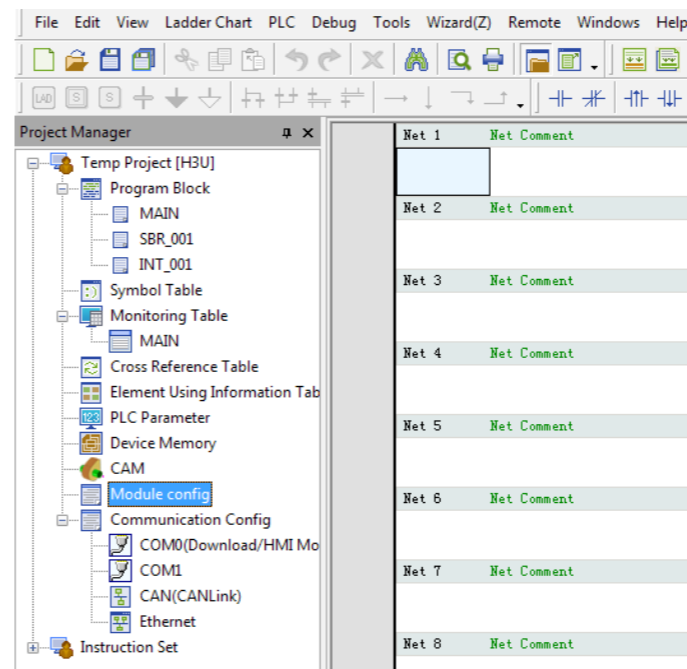

- Select the module GL10-1600ETP to be added from the module list. Double-click the module to automatically add it to the expansion rack, or use left mouse button to drag it onto the expansion rack.

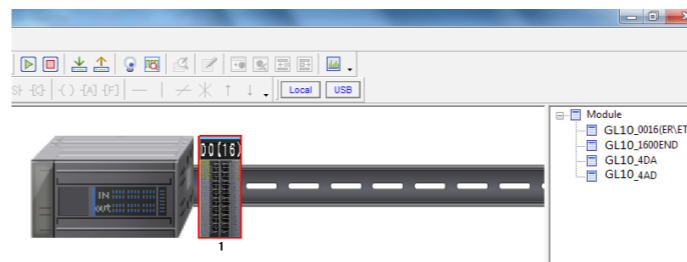

- Perform programming on outputs of the GL10-0016ETP by using ladder diagram.

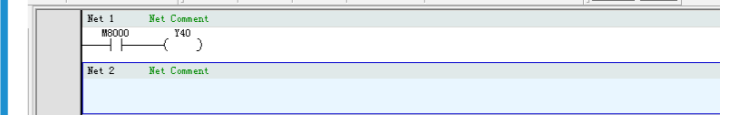

Note:

- Y represents the bit component used to control PLC's output. When a local expansion module is connected to the H3U, the Y port on the expansion module is numbered in a way that the number closely and sequentially follows the number of the Y port on the main module. For example, when the GL10-0016ETP expansion module is connected to the H3U-3232MT main module, as the last series number of the Y port on the main module is Y37, series numbers of the Y port on the expansion module are programmed to Y40-Y57.
 - SN of Y ports of the expansion module starts from units position 0 in octonary system.
- After successful compiling, download the project and run it.

INOVANCE Warranty Agreement

- Inovance provides an 18-month free warranty to the equipment itself from the date of manufacturing for the failure or damage under normal use conditions.
- Within the warranty period, maintenance will be charged for the damage caused by the following reasons:
 - Improper use or repair/modification without prior permission
 - Fire, flood, abnormal voltage, natural disasters and secondary disasters
 - Hardware damage caused by dropping or transportation after procurement
 - Operations not following the user instructions
 - Damage out of the equipment (for example, external device factors)
- The maintenance fee is charged according to the latest Maintenance Price List of Inovance.
- If there is any problem during the service, contact Inovance's agent or Inovance directly.
- Inovance reserves the rights for explanation of this agreement.

Suzhou Inovance Technology Co., Ltd.
 Address: No.16, Youxiang Road, Yuxi Town, Wuzhong District, Suzhou 215104, P.R. China
 Website: <http://www.inovance.com>